

Article number: 2035025817544ST

Description: E+G Levelling sets GN 350.2-58-17.5-44-ST

Measures

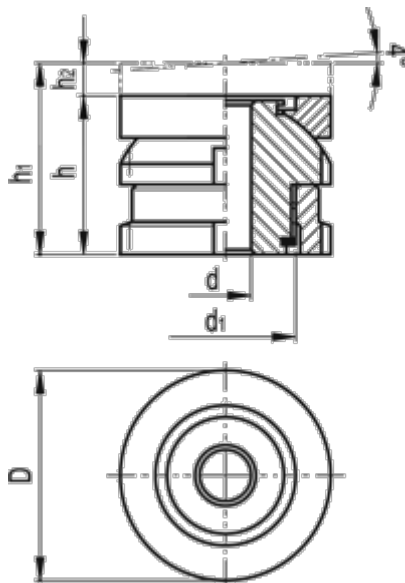

C-spanner DIN 1810 = A58-62

d = 17.5

D = 58

d1 = M40x1.5

For screw = M16

h = 44

h1 = 53

h2 = 9

Max static load (kN) = 148

Static preload (kN) = 92.9

Weight (g) = 665